

### ■ PRODUCT CHARACTERISTICS

|                |       |
|----------------|-------|
| VR(@IC=0.5mA)  | 100V  |
| VF(Typ@IF=10A) | 0.78V |
| IR(@VR=100V)   | 50uA  |
| ID             | 20A   |

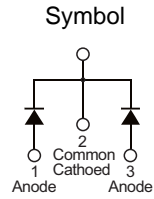

### ■ MECHANICAL CHARACTERISTICS

- \* Case: epoxy, molded
- \* Finish: all external surfaces corrosion resistant and terminal
- \* Leads are readily solderable
- \* Leads temperature for soldering purposes: 260°C Max for 10 seconds

### ■ FEATURES

- \* Guard ring for stress protection
- \* Low forward voltage
- \* Low power loss/high efficiency
- \* High surge capacity
- \* Low stored charge majority carrier conduction
- \* Pb free package are available

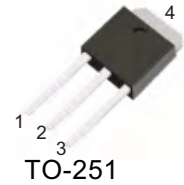
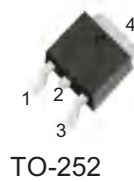

### ■ ORDER INFORMATION

| Order codes  |           | Package | Packing         |
|--------------|-----------|---------|-----------------|
| Halogen-free | Halogen   |         |                 |
| N/A          | RST20100C | TO-251  | 70pieces/Tube   |
| N/A          | RST20100D | TO-252  | 2500pieces/Reel |

### ■ MAXIMUM RATINGS (Each diode leg)

| Parameter  | Symbol         | Value        | Unit |
|--|----------------|--------------|------|
| Peak repetitive reverse voltage  | $V_{RRM}$      | 100          | V    |
| Average rectified output current   | Total          | 20           | A    |
|  | Per leg        | 10           | A    |
| Non-repetitive peak forward surge current 8.3ms single half sine-wave superimposed on reate load | $I_{FSM}$      | 200          | A    |
| Operating and storage temperature range  | $T_J, T_{STG}$ | -55 to + 175 | °C   |

### ■ ELECTRICAL CHARACTERISTICS

| Parameter                       | Symbol | Conditions                  | Min | Typ  | Max  | Unit |
|---------------------------------|--------|-----------------------------|-----|------|------|------|
| Peak repetitive reverse voltage | $B_V$  | $I_C=0.5mA, T_J=25^\circ C$ | 100 | -    | -    | V    |
| Forward voltage drop            | $V_F$  | $I_F=10A, T_J=25^\circ C$   | -   | 0.78 | 0.83 | V    |
| Leakage current                 | $I_R$  | $V_R=100V, T_J=25^\circ C$  | -   | -    | 0.05 | mA   |
|                                 |        | $V_R=100V, T_J=125^\circ C$ | -   | -    | 6    |      |

■ TYPICAL CHARACTERISTICS

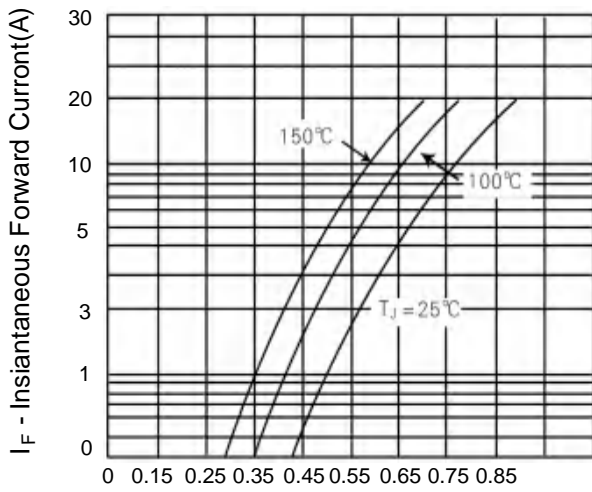

Figure 1. Typical Forward Voltage Per Diode

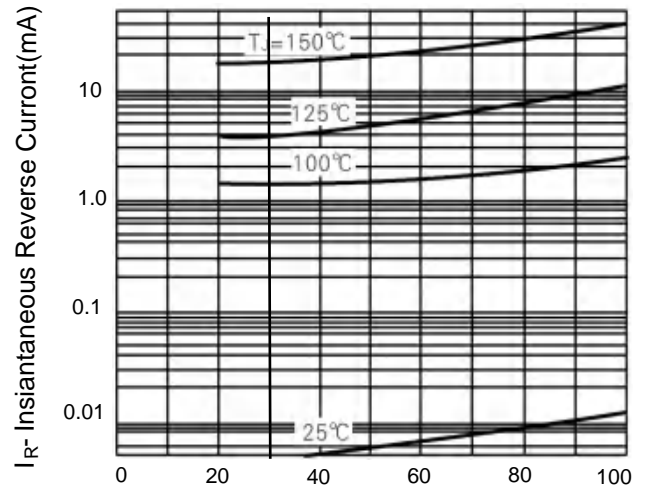

Figure 2. Typical Reverse Current Per Diode

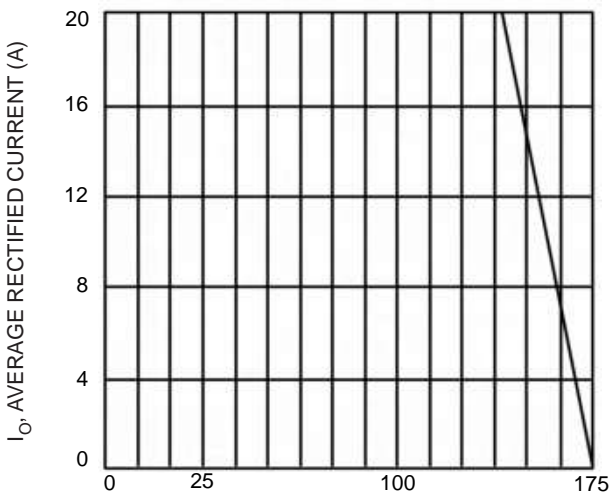

Fig.3 Forward Current Derating Curve

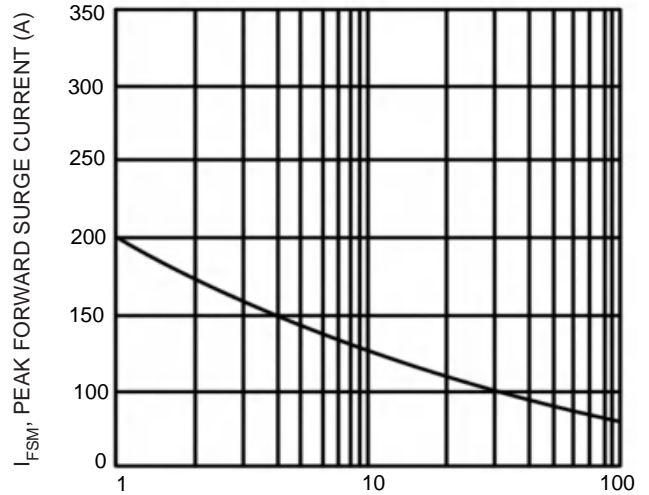
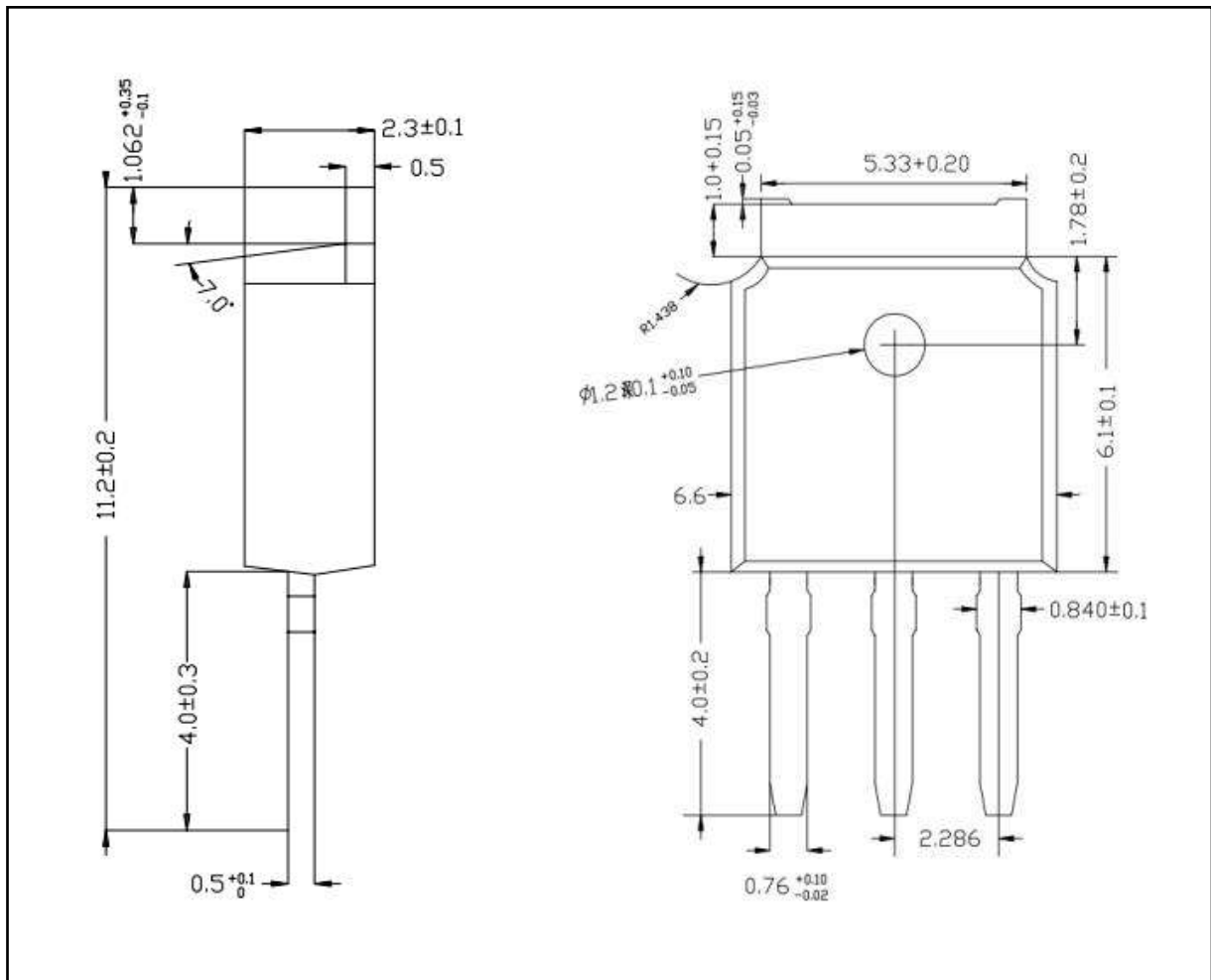

Fig.4 Max Non-Repetitive Surge Current

■ TO-251 PACKAGE OUTLINE DIMENSIONS



■ TO-252 PACKAGE OUTLINE DIMENSIONS

