

### PRODUCT CHARACTERISTICS

BVCBO	700V
BVCEO	400V
HFE@5V2A	8-40
IC	12A

### Symbol

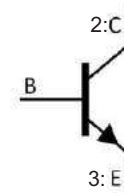

### APPLICATIONS

- Fluorescent lamp
- Electronic ballast
- Electronic transformer
- Switch mode power supply

### FEATURES

- \*  $V_{CEO(SUS)}$  400V
- \* 700V Blocking Capability

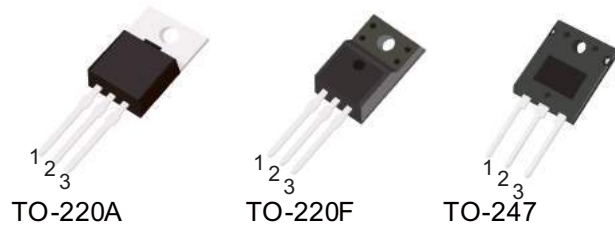

### ORDER INFORMATION

Order codes		Package	Packing
Halogen-Free	Halogen		
N/A	RST13009DF	TO-220F	50 pieces/Tube
N/A	RST13009DA	TO-220	50 pieces/Tube
N/A	RST13009DW	TO-247S	30 pieces/Tube

### ABSOLUTE MAXIMUM RATING

PARAMETER	SYMBOL	RATINGS	UNIT
Collector-Emitter Voltage	$V_{CEO}$	400	V
Collector-Emitter Voltage ( $V_{BE}=-1.5V$ )	$V_{CEV}$	700	V
Emitter Base Voltage	$V_{EBO}$	9	V
Collector Current	Continuous	$I_C$	12
	Peak (Note 3)	$I_{CM}$	24
Base Current	Continuous	$I_B$	6
	Peak (Note 3)	$I_{BM}$	12
Emitter Current	Continuous	$I_E$	18
	Peak (Note 3)	$I_{EM}$	36
Power Dissipation	TO-220	$P_D$	2
	TO-220F		0.7
	TO-247		80
Derate above 25°C	TO-220	$P_D$	16
	TO-220F		5.6
	TO-247		640
Junction Temperature	$T_J$	+150	°C
Storage Temperature	$T_{STG}$	-40 ~ +150	°C

- Note: 1. Pulse Test: Pulse Width = 5ms, Duty Cycle  $\leq 10\%$   
 2. Absolute maximum ratings are those values beyond which the device could be permanently damaged. Absolute maximum ratings are stress ratings only and functional device operation is not implied.  
 3. Pulse Test: Pulse Width = 300 $\mu$ s, Duty Cycle = 2%

### THERMAL DATA

PARAMETER	SYMBOL	RATINGS	UNIT
Junction to Ambient	$\theta_{JA}$	TO-220	54
		TO-220F	62.5
		TO-247	21
Junction to Case	$\theta_{JC}$	TO-220	4
		TO-220F	3.13
		TO-247	1.55

■ ELECTRICAL CHARACTERISTICS ( $T_C=25^\circ\text{C}$ , unless otherwise noted)

PARAMETER	SYMBOL	TEST CONDITIONS	MIN	TYP	MAX	UNIT
<b>OFF CHARACTERISTICS (Note)</b>						
Collector- Emitter Sustaining Voltage	$V_{CE0}$	$I_C = 10\text{mA}, I_B = 0$	400			V
Collector Cutoff Current	$I_{CEV}$	$V_{BE(OFF)} = 1.5V_{DC}$			1	mA
$V_{CBO}=\text{Rated Value}$		$V_{BE(OFF)} = 1.5V_{DC}, T_C = 100^\circ\text{C}$			5	
Emitter Cutoff Current	$I_{EBO}$	$V_{EB} = 9V_{DC}, I_C = 0$			1	mA
<b>ON CHARACTERISTICS (Note)</b>						
DC Current Gain	$h_{FE1}$	$I_C = 5A, V_{CE} = 5V$			40	
	$h_{FE2}$	$I_C = 8A, V_{CE} = 5V$ $I_C = 5A, I_B = 1A$			30 1	V
Current-Emitter Saturation Voltage	$V_{CE(SAT)}$	$I_C = 8A, I_B = 1.6A$			1.5	V
		$I_C = 12A, I_B = 3A$			3	V
		$I_C = 8A, I_B = 1.6A, T_C = 100^\circ\text{C}$			2	V
Base-Emitter Saturation Voltage	$V_{BE(SAT)}$	$I_C = 5A, I_B = 1A$			1.2	V
		$I_C = 8A, I_B = 1.6A$			1.6	V
		$I_C = 8A, I_B = 1.6A, T_C = 100^\circ\text{C}$			1.5	V
<b>DYNAMIC CHARACTERISTICS</b>						
Transition frequency	$f_T$	$I_C = 500\text{mA}, V_{CE} = 10V, f = 1\text{MHz}$	4			MHz
Output Capacitance	$C_{OB}$	$V_{CB} = 10V, I_E = 0, f = 0.1\text{MHz}$		180		pF
<b>SWITCHING CHARACTERISTICS (Resistive Load, Table 1)</b>						
Delay Time	$t_{DLY}$	$V_{CC} = 125V_{dc}, I_C = 8A$ $I_{B1} = I_{B2} = 1.6A, t_P = 25\mu\text{s}$ Duty Cycle $\leq 1\%$		0.06	0.1	$\mu\text{s}$
Rise Time	$t_R$		0.45	1	$\mu\text{s}$	
Storage Time	$t_S$		1.3	3	$\mu\text{s}$	
Fall Time	$t_F$		0.2	0.7	$\mu\text{s}$	
<b>Inductive Load, Clamped (Table 1, Fig. 13)</b>						
Voltage Storage Time	$t_S$	$I_C=8A, V_{CLAMP}=300V, I_{B1}=1.6A$		0.92	2.3	$\mu\text{s}$
Crossover Time	$t_C$	$V_{BE(OFF)} = 5V, T_C = 100^\circ\text{C}$		0.12	0.7	$\mu\text{s}$

Note: Pulse Test: Pulse Width =  $300\mu\text{s}$ , Duty Cycle = 2%

### ■ TYPICAL CHARACTERISTICS

Fig. 1 Forward Bias Safe Operating Area

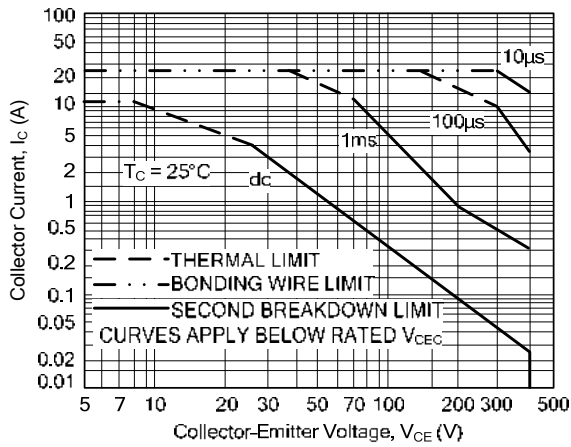

Fig. 2 Reverse Bias Switching Safe Operating Area

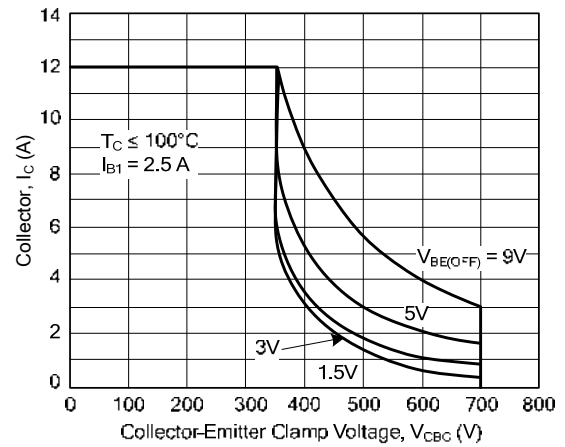

Fig. 3 Forward Bias Power Derating

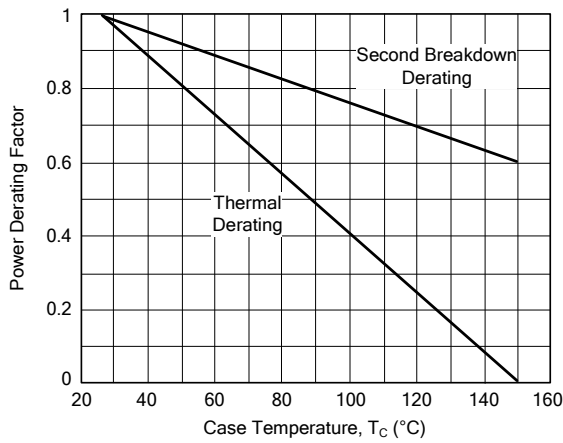
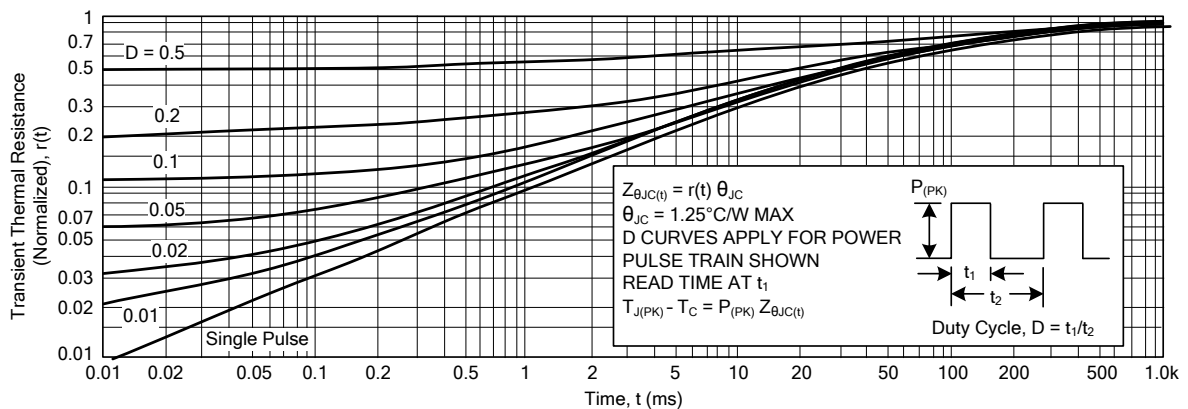

Fig. 4 Typical Thermal Response [ $Z_{\theta JC}(t)$ ]



■ TYPICAL CHARACTERISTICS(Cont.)

Fig. 5 DC Current Gain

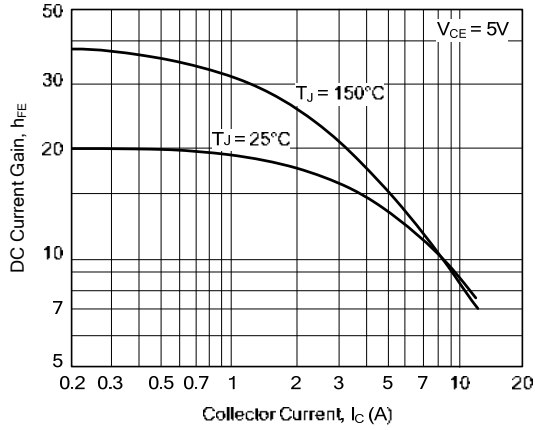

Fig. 6 Collector Saturation Region

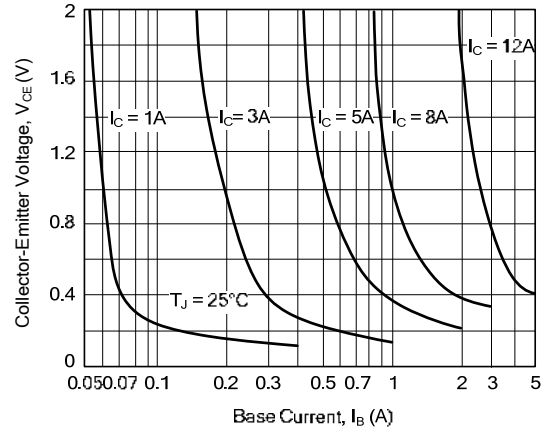

Fig. 7 Base-Emitter Saturation Voltage

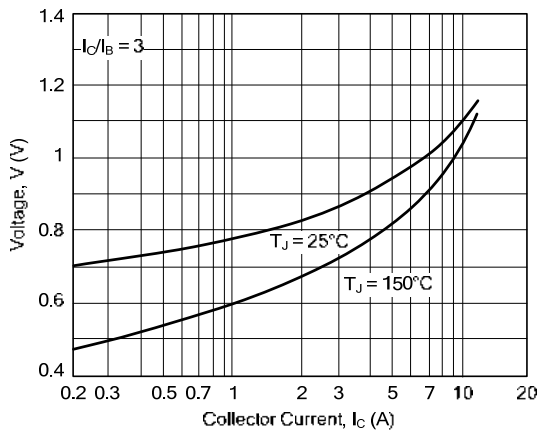

Fig. 8 Collector-Emitter Saturation Voltage

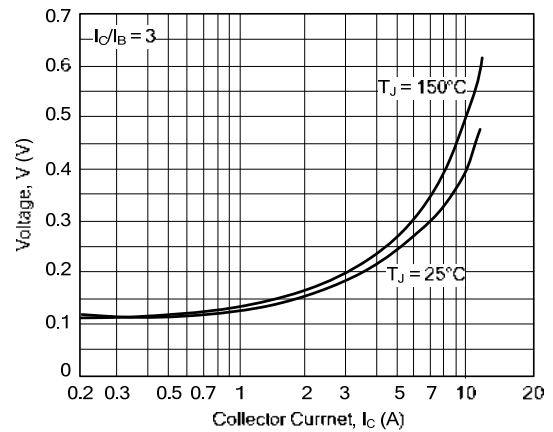

Fig. 9 Collector Cutoff Region

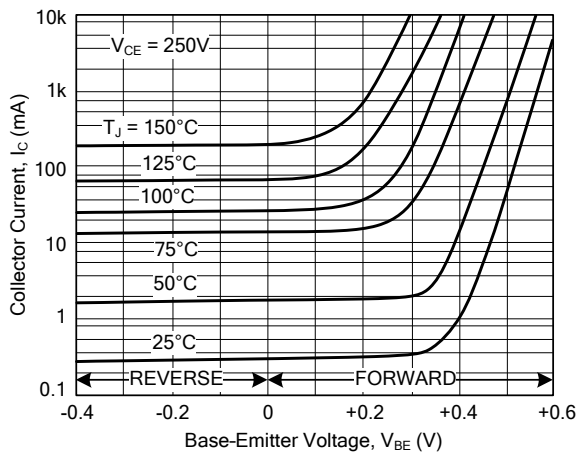
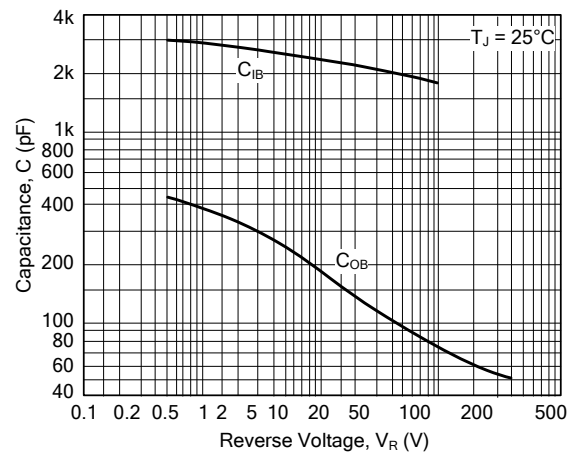

Fig. 10 Capacitance



### RESISTIVE SWITCHING PERFORMANCE

Fig. 11. Turn-On Time

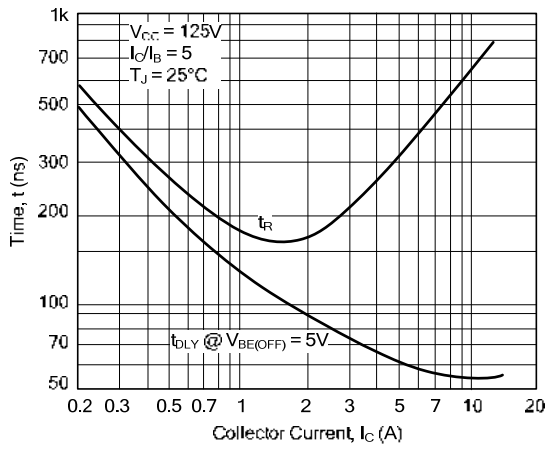

Fig. 12 Turn-Off Time

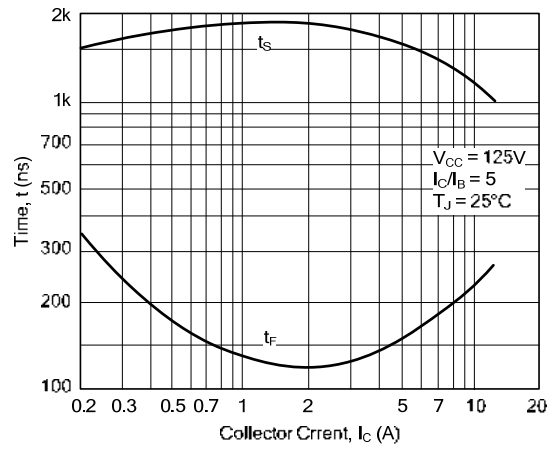
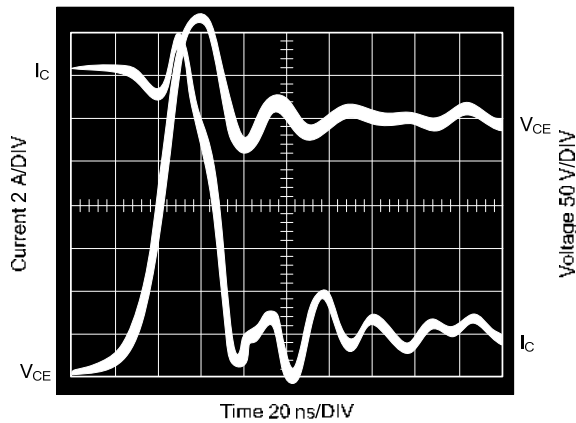
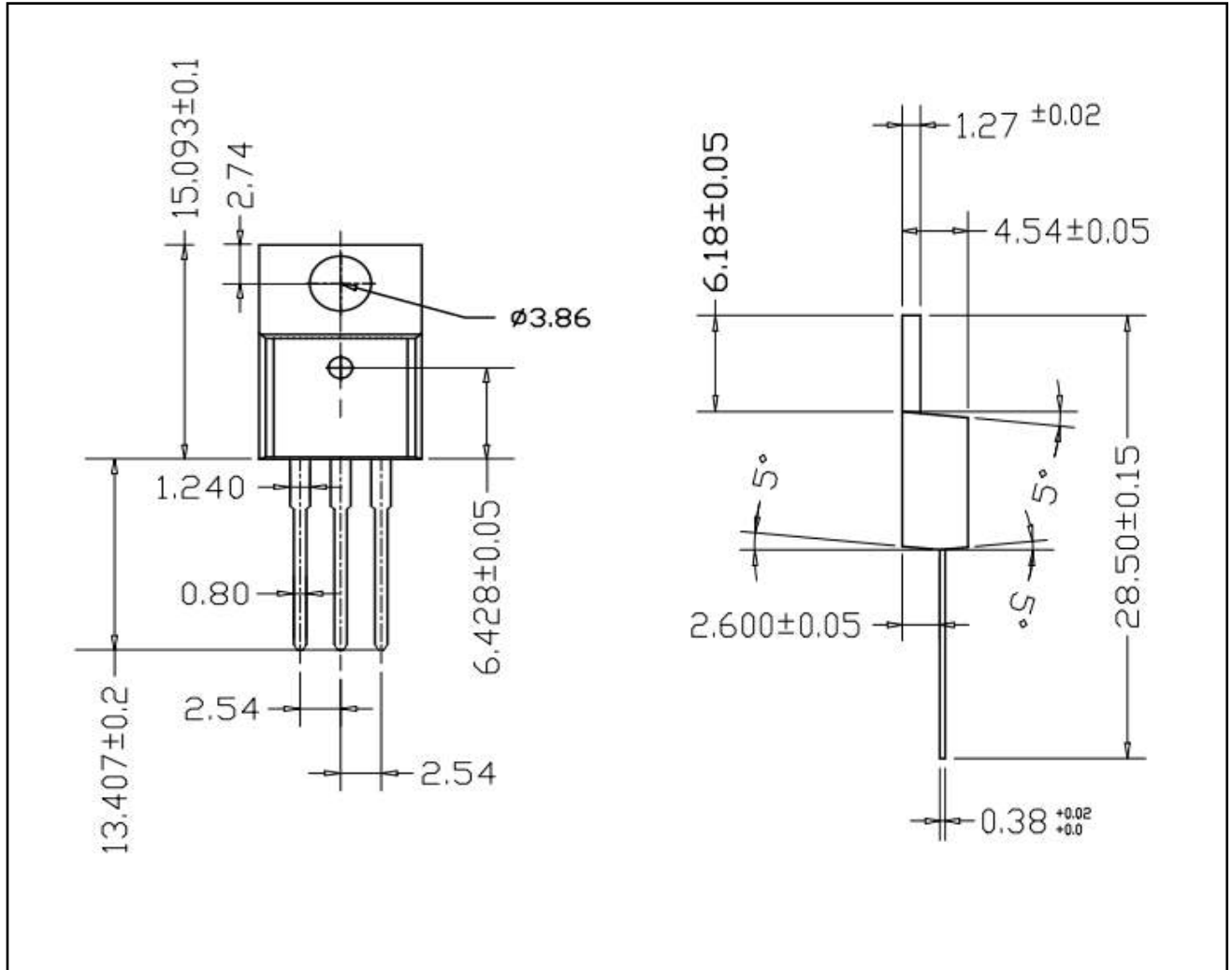

Fig. 13 Typical Inductive Switching Waveforms (at 300V and 12A with  $I_{B1} = 2.4A$  and  $V_{BE(OFF)} = 5V$ )





### ■ TO-220-3L PACKAGE OUTLINE DIMENSIONS



### ■ TO-247-3L PACKAGE OUTLINE DIMENSIONS

