

PRODUCT CHARACTERISTICS

BVCBO	700V
BVCEO	400V
HFE@5V2A	8-40
IC	8A

Symbol

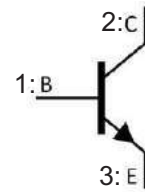

APPLICATIONS

- Fluorescent lamp
- Electronic ballast
- Electronic transformer
- Switch mode power supply

FEATURES

- * $V_{CEO(SUS)}$ 400V
- * 700V Blocking Capability



ORDER INFORMATION

Order codes		Package	Packing
Halogen-Free	Halogen		
N/A	RST13007MF	TO-220F	50 pieces/Tube
N/A	RST13007MA	TO-220	50 pieces/Tube

ABSOLUTE MAXIMUM RATING

PARAMETER	SYMBOL	RATINGS	UNIT
Collector-Emitter Sustaining Voltage	V_{CEO}	400	V
Collector-Emitter Breakdown Voltage	V_{CBO}	700	V
Emitter-Base Voltage	V_{EBO}	9.0	V
Collector Current	Continuous	I_C	8.0
	Peak (1)	I_{CM}	16
Base Current	Continuous	I_B	4.0
	Peak (1)	I_{BM}	8.0
Emitter Current	Continuous	I_E	12
	Peak (1)	I_{EM}	24
Total Device Dissipation	$T_C = 25^\circ\text{C}$	P_D	80
Operating and Storage Junction Temperature	T_J, T_{STG}	-55~+150	$^\circ\text{C}$

Note: Absolute maximum ratings are those values beyond which the device could be permanently damaged. Absolute maximum ratings are stress ratings only and functional device operation is not implied.

THERMAL DATA

PARAMETER	SYMBOL	RATINGS	UNIT
Junction to Case	θ_{JC}	1.56	$^\circ\text{C/W}$
Junction to Ambient	θ_{JA}	62.5	$^\circ\text{C/W}$

Note 1: Pulse Test: Pulse Width = 5.0 ms, Duty Cycle \leq 10%.

Measurement made with thermocouple contacting the bottom insulated mounting surface of the package (in a location beneath the die), the device mounted on a heatsink with thermal grease applied at a mounting torque of 6 to 8•lbs.

■ ELECTRICAL CHARACTERISTICS ($T_C=25^\circ\text{C}$, unless otherwise noted)

PARAMETER	SYMBOL	TEST CONDITIONS	MIN	TYP	MAX	UNIT
Collector-Emitter Sustaining Voltage	$V_{CEO(SUS)}$	$I_C=10\text{mA}$, $I_B=0$	400			V
Collector Cutoff Current	I_{CBO}	$V_{CES}=700\text{V}$			0.1	mA
		$V_{CES}=700\text{V}$, $T_C=125^\circ\text{C}$			1.0	mA
Emitter Cutoff Current	I_{EBO}	$V_{EB}=9.0\text{V}$, $I_C=0$			100	μA
DC Current Gain	h_{FE1}	$I_C=2.0\text{A}$, $V_{CE}=5.0\text{V}$	8.0		40	
	h_{FE2}	$I_C=5.0\text{A}$, $V_{CE}=5.0\text{V}$	5.0		30	
Collector-Emitter Saturation Voltage	$V_{CE(SAT)}$	$I_C=2.0\text{A}$, $I_B=0.4\text{A}$			1.0	V
		$I_C=5.0\text{A}$, $I_B=1.0\text{A}$			2.0	V
		$I_C=8.0\text{A}$, $I_B=2.0\text{A}$			3.0	V
		$I_C=5.0\text{A}$, $I_B=1.0\text{A}$, $T_C=100^\circ\text{C}$			3.0	V
Base-Emitter Saturation Voltage	$V_{BE(SAT)}$	$I_C=2.0\text{A}$, $I_B=0.4\text{A}$			1.2	V
		$I_C=5.0\text{A}$, $I_B=1.0\text{A}$			1.6	V
		$I_C=5.0\text{A}$, $I_B=1.0\text{A}$, $T_C=100^\circ\text{C}$			1.5	V
Current-Gain-Bandwidth Product	f_T	$I_C=500\text{mA}$, $V_{CE}=10\text{V}$, $f=1.0\text{MHz}$	4.0	14		MHz
Output Capacitance	C_{ob}	$V_{CB}=10\text{V}$, $I_E=0$, $f=0.1\text{MHz}$		80		pF
Resistive Load (Table 1)						
Delay Time	t_D	$V_{CC}=125\text{V}$, $I_C=5.0\text{A}$, $I_{B1}=I_{B2}=1.0\text{A}$, $t_p=25\mu\text{s}$, Duty Cycle $\leq 1.0\%$		0.025	0.1	μs
Rise Time	t_R			0.5	1.5	μs
Storage Time	t_S			1.8	3.0	μs
Fall Time	t_F			0.23	0.7	μs

* Pulse Test: Pulse Width $\leq 300\mu\text{s}$, Duty Cycle $\leq 2.0\%$

■ TYPICAL CHARACTERISTICS

Figure 2. Base-Emitter Saturation Voltage

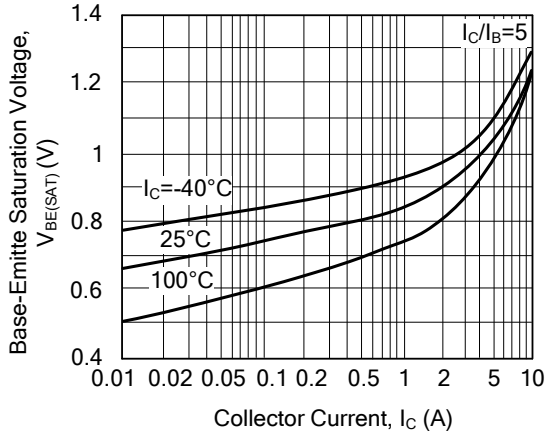

Figure 3. Collector-Emitter Saturation Voltage

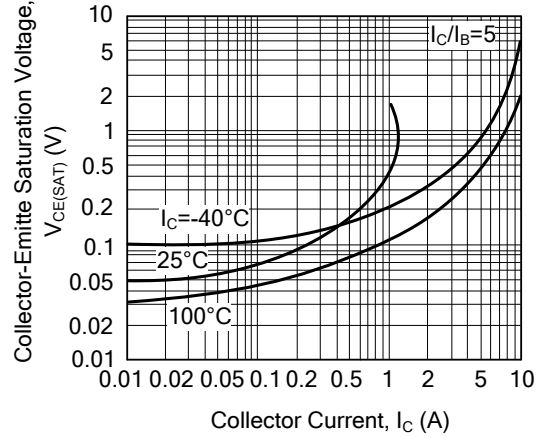

Figure 4. Collector Saturation Region

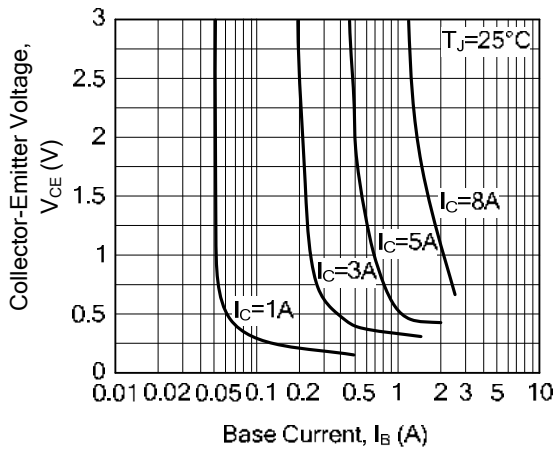

Figure 5. DC Current Gain

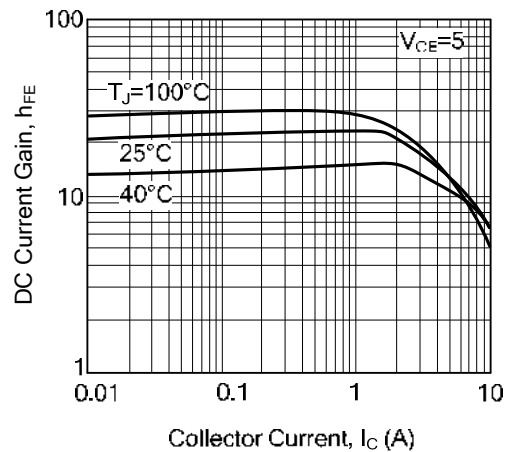

Figure 6. Capacitance

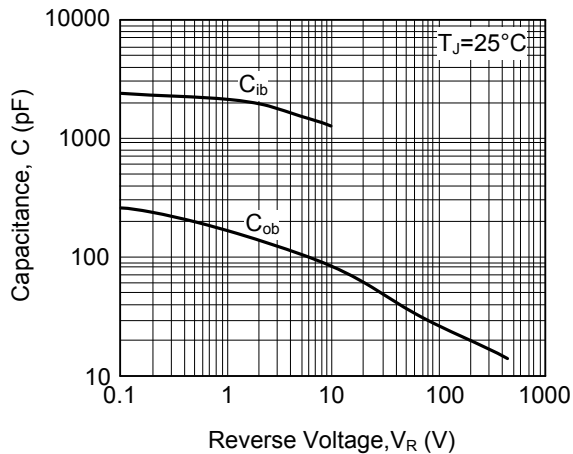
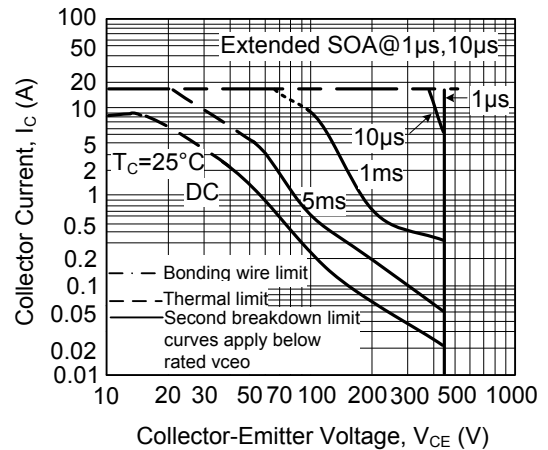

Figure 7. Maximum Forward Bias Safe Operating Area



■ TYPICAL CHARACTERISTICS(Cont.)

Figure 8. Maximum Reverse Bias Switching Safe Operating Area

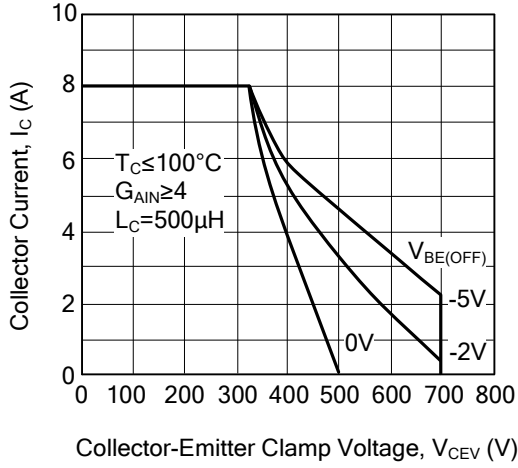

Figure 9. Forward Bias Power Derating

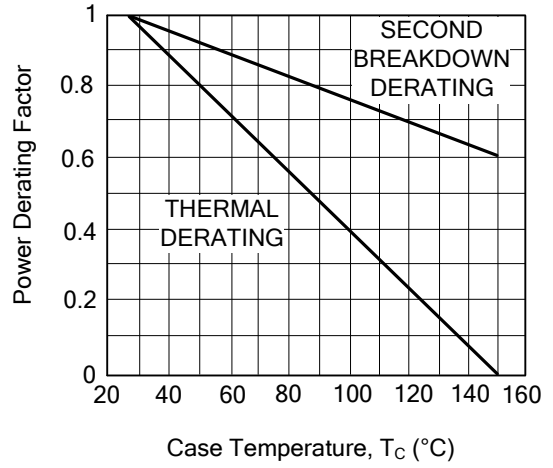

Figure 10. Turn-On Time(Resistive Load)

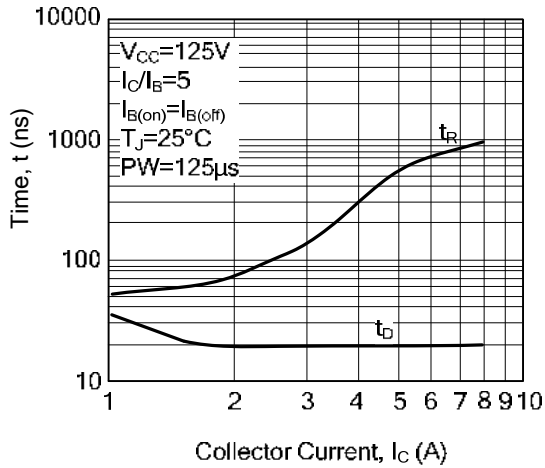
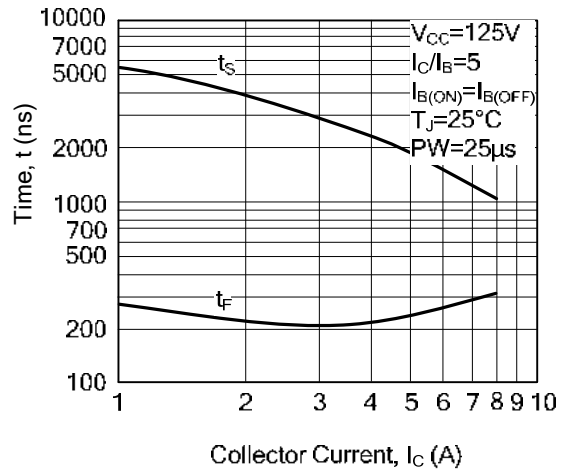
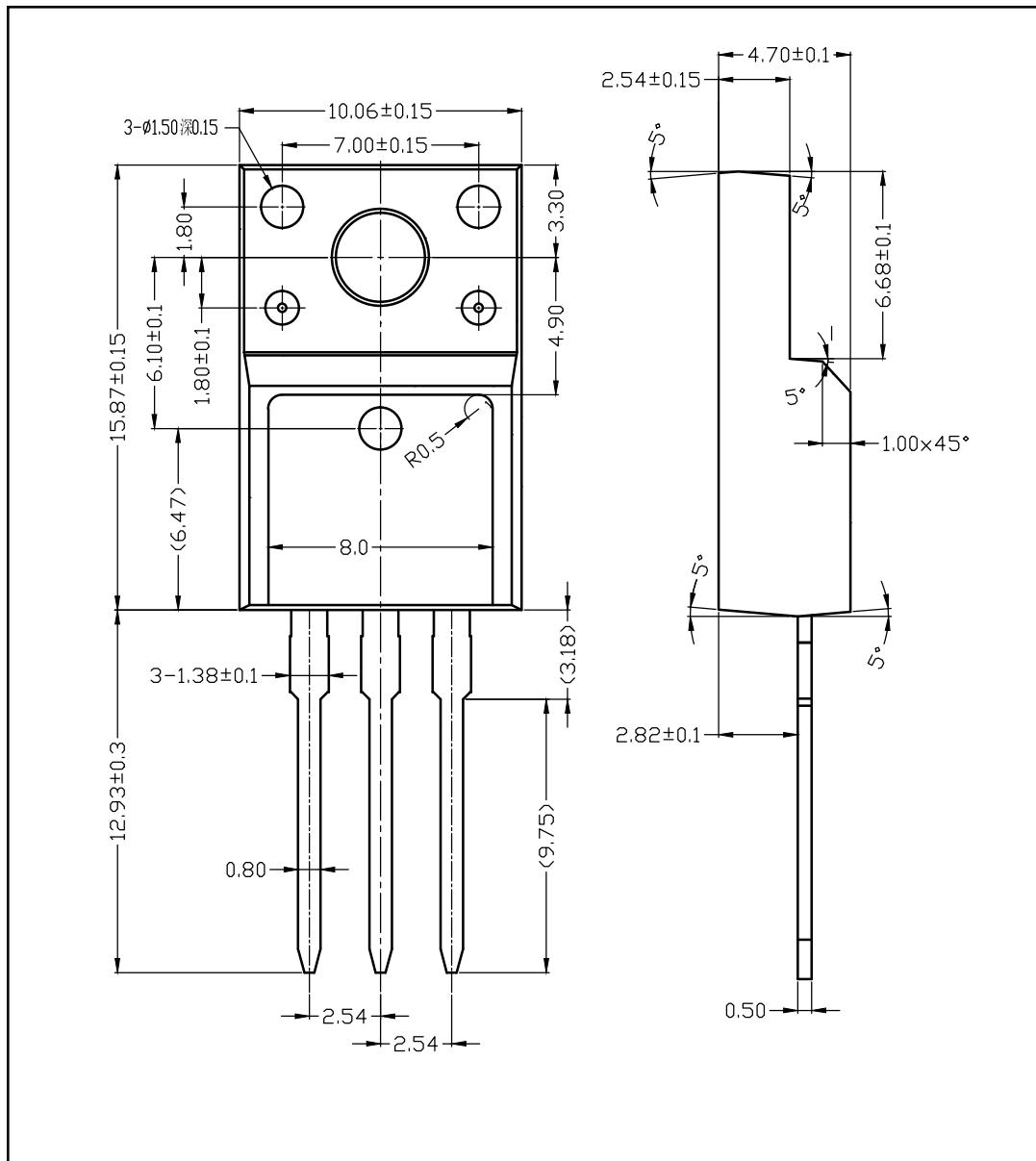

Figure 11. Turn-Off Time(Resistive Load)



■ TO-220F-3L PACKAGE OUTLINE DIMENSIONS



■ TO-220-3L PACKAGE OUTLINE DIMENSIONS

