

### PRODUCT CHARACTERISTICS

VR(@IC=0.5mA)	60V
VF(Typ@IF=5A)	0.64V
IR(@VR=60V)	50uA
ID	10A

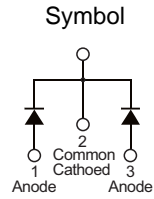

### MECHANICAL CHARACTERISTICS

- \* Case: epoxy, molded
- \* Finish: all external surfaces corrosion resistant and terminal
- \* Leads are readily solderable
- \* Leads temperature for soldering purposes: 260°C Max for 10 seconds

### FEATURES

- \* Guard ring for stress protection
- \* Low forward voltage
- \* Low power loss/high efficiency
- \* High surge capacity
- \* Low stored charge majority carrier conduction
- \* Pb free package are available

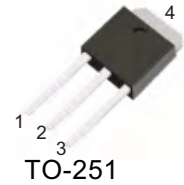

### ORDER INFORMATION

Order codes		Package	Packing
Halogen-free	Halogen		
N/A	RST1060C	TO-251	70pieces/Tube
N/A	RST1060D	TO-252	2500pieces/Reel

### MAXIMUM RATINGS (Each diode leg)

Parameter	Symbol	Value	Unit
Peak repetitive reverse voltage	$V_{RRM}$	60	V
Average rectified output current	Total	10	A
	Per leg	5	A
Non-repetitive peak forward surge current 8.3ms single half sine-wave superimposed on reate load	$I_{FSM}$	150	A
Operating and storage temperature range	$T_J, T_{STG}$	-55 to + 175	°C

### ELECTRICAL CHARACTERISTICS

Parameter	Symbol	Conditions	Min	Typ	Max	Unit
Peak repetitive reverse voltage	$B_V$	$I_C=0.5mA, T_J=25^\circ C$	60	-	-	V
Forward voltage drop	$V_F$	$I_F=5A, T_J=25^\circ C$	-	0.64	0.67	V
Leakage current	$I_R$	$V_R=60V, T_J=25^\circ C$	-	-	0.05	mA
		$V_R=60V, T_J=125^\circ C$	-	-	6	

■ TYPICAL CHARACTERISTICS

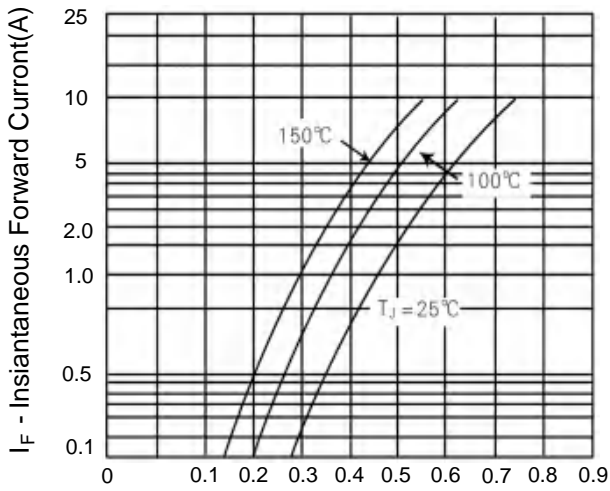

Figure 1. Typical Forward Voltage Per Diode

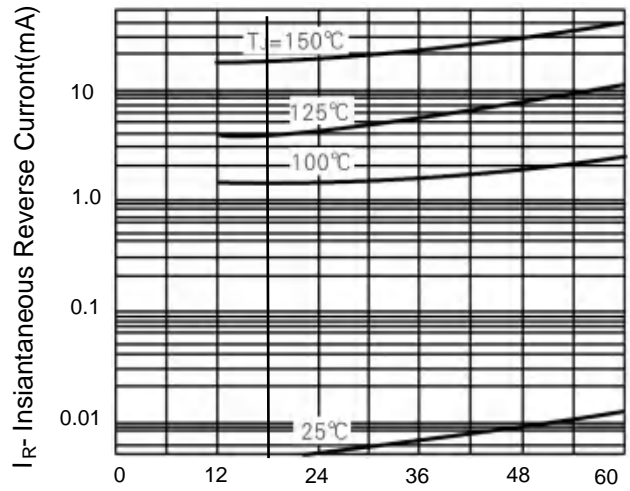

Figure 2. Typical Reverse Current Per Diode

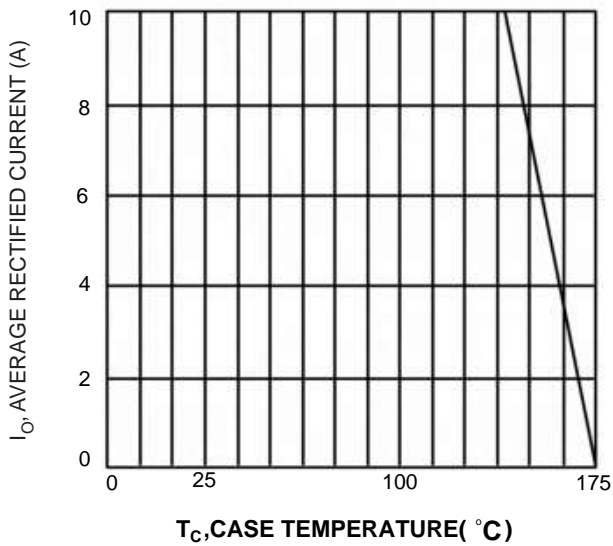

Fig.3 Forward Current Derating Curve

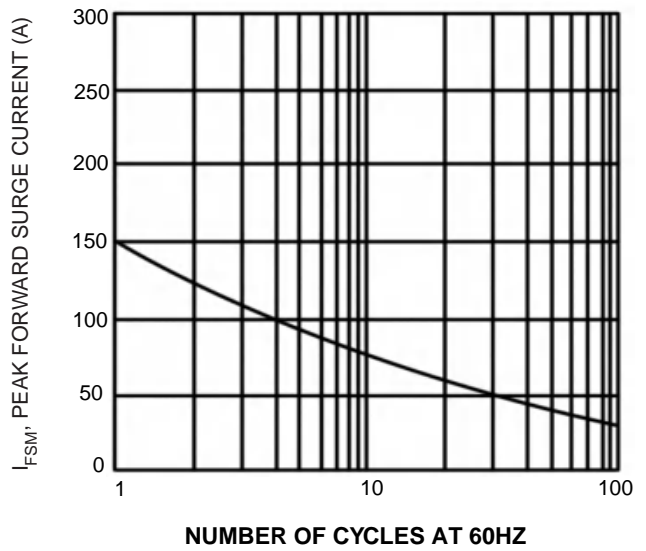
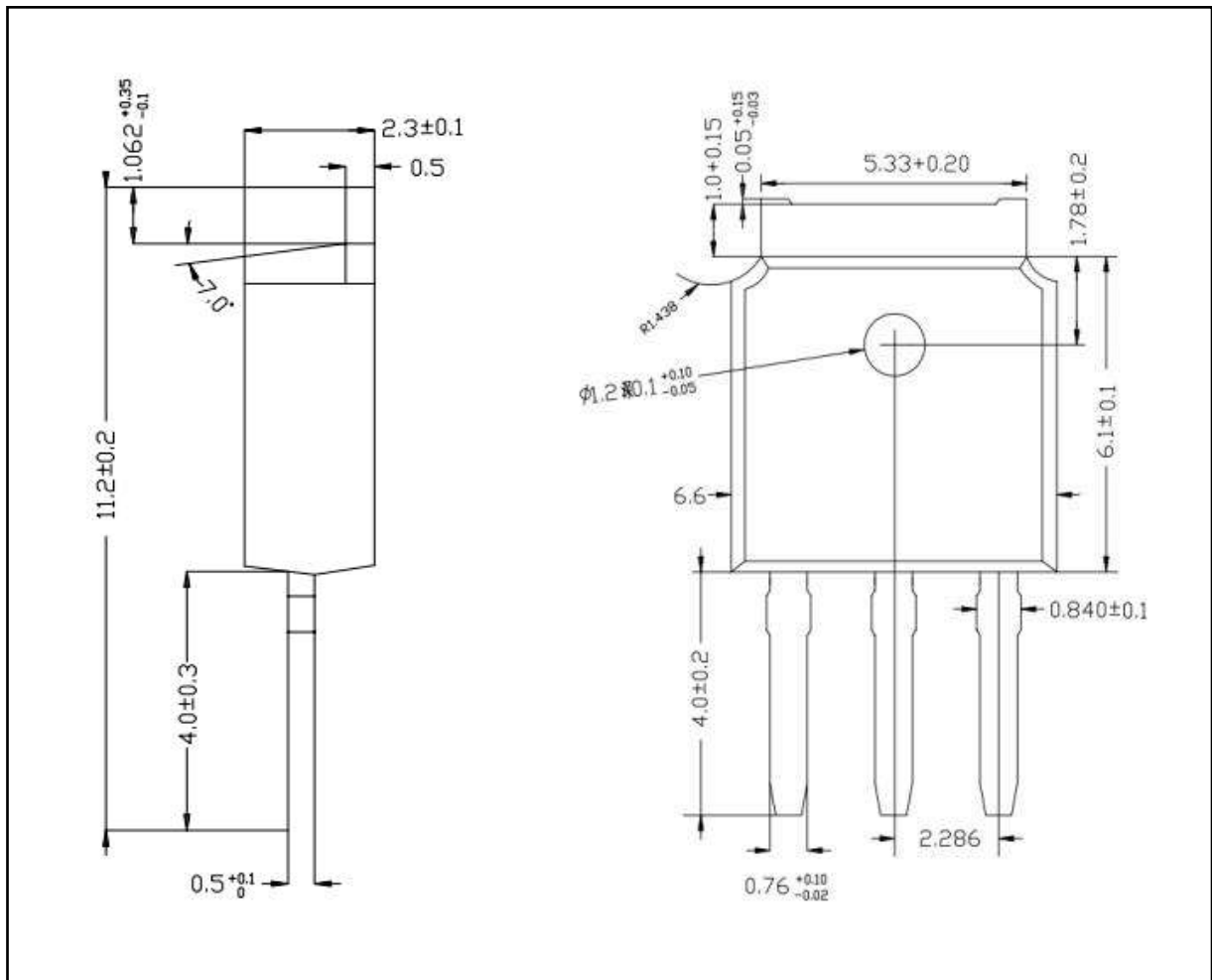

Fig.4 Max Non-Repetitive Surge Current

■ TO-251 PACKAGE OUTLINE DIMENSIONS



■ TO-252 PACKAGE OUTLINE DIMENSIONS

