

<p>NPN型 小功率 贴片三极管 NPN EPITAXIAL PLANAR TRANSISTOR SMD</p>	<p>2SC1623 对应其他工业型号 2SC1623</p>
<ul style="list-style-type: none"> ■ Excellent hFE linearity ■ Low noise ■ Transistor Polarity: NPN ■ Transistor pinout: BEC ■ SOT-23 Package ■ Marking Code: L6 ■ hFE: 200-400 	

<p style="text-align: center;">Inner circuit</p>  <p style="text-align: center;">SOT-23 内部结构</p>	<p style="text-align: center;">2SC1623</p>  <p style="text-align: center;">SOT-23 管脚排列</p> <p style="text-align: right;">1. Base 2. Emitter 3. Collector</p>	<p style="text-align: center;">元件标识 (打印)</p>  <p style="text-align: center;">DEVICE MARKING</p>
--	--	---

■ CLASSIFICATION OF hFE

RANK	Low	Typ	High
RANGE	100-200	200~400	4000~1000

■ MAXIMUM RATINGS

Symbol	Parameter	Value	Unit
V_{CBO}	Collector-Base Voltage	60	V
V_{CEO}	Collector-Emitter Voltage	50	V
V_{EBO}	Emitter-Base Voltage	5	V
I_C	Collector Current	100	mA
P_C	Collector Power Dissipation	200	mW
T_J, T_{stg}	Operation Junction and Storage Temperature Range	-55~+150	°C

■ ELECTRICAL CHARACTERISTICS ($T_A=25^{\circ}\text{C}$ unless otherwise noted)

Characteristic	Symbol	Test Condition	Min	Typ	Max	Unit
Collector-base breakdown voltage	$V_{(BR)CBO}$	$I_C=100\mu\text{A}, I_E=0$	60			V
Collector-emitter breakdown voltage	$V_{(BR)CEO}$	$I_C=1\text{mA}, I_B=0$	50			V
Emitter-base breakdown voltage	$V_{(BR)EBO}$	$I_E=100\mu\text{A}, I_C=0$	5			V
Collector cut-off current	I_{CBO}	$V_{CB}=60\text{V}, I_E=0$			0.1	μA
Emitter cut-off current	I_{EBO}	$V_{EB}=5\text{V}, I_C=0$			0.1	μA
DC current gain	h_{FE}	$V_{CE}=6\text{V}, I_C=1\text{mA}$	90	200	600	
Collector-emitter saturation voltage	$V_{CE(sat)}$	$I_C=100\text{mA}, I_B=10\text{mA}$			0.3	V
Base-emitter saturation voltage	$V_{BE(sat)}$	$I_C=100\text{mA}, I_B=10\text{mA}$			1	V
Transition frequency	f_T	$V_{CE}=6\text{V}, I_C=10\text{mA}$		250		MHz

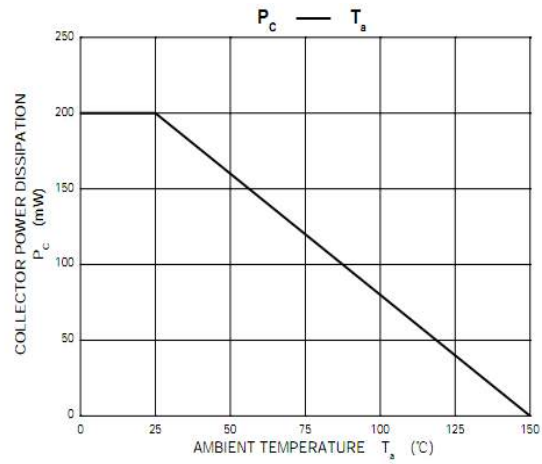
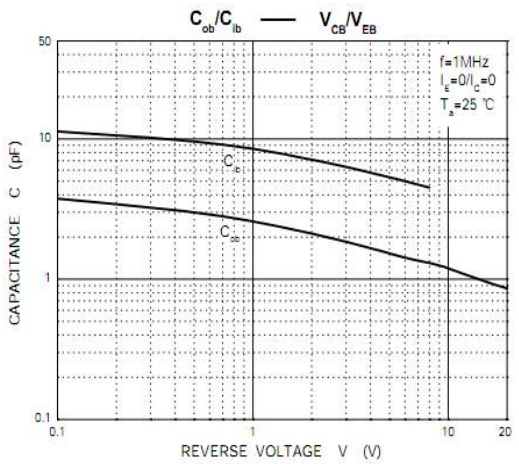
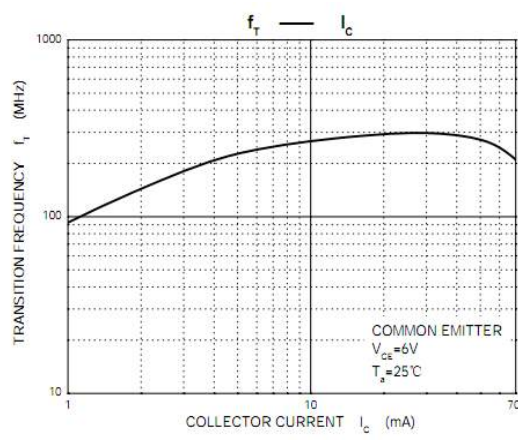
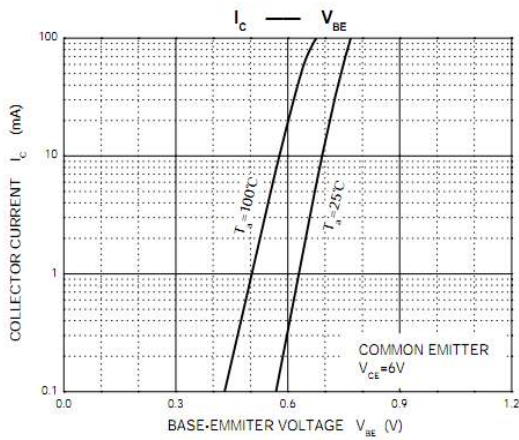
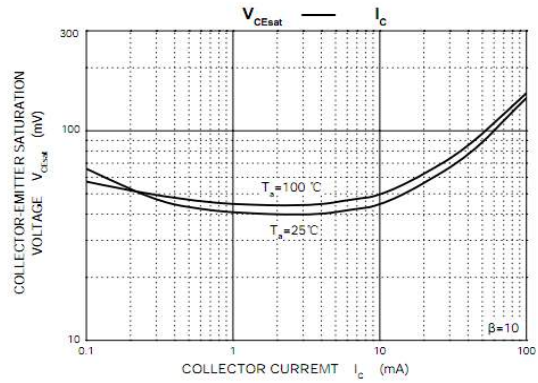
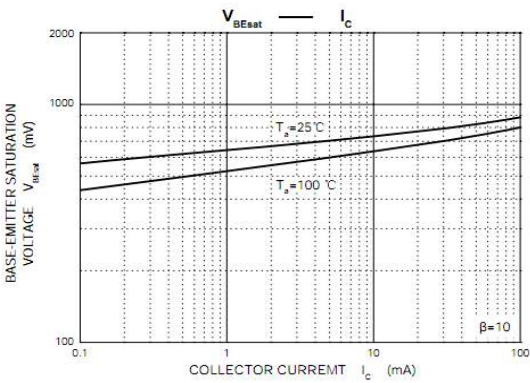
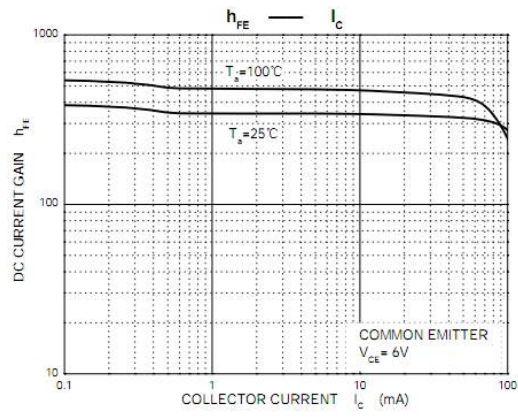
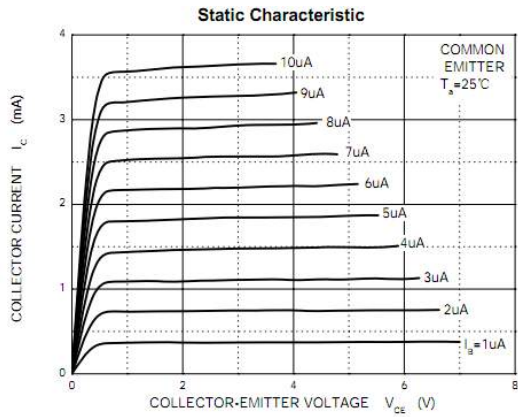

■ DIMENSION

单位 (UNIT) : mm

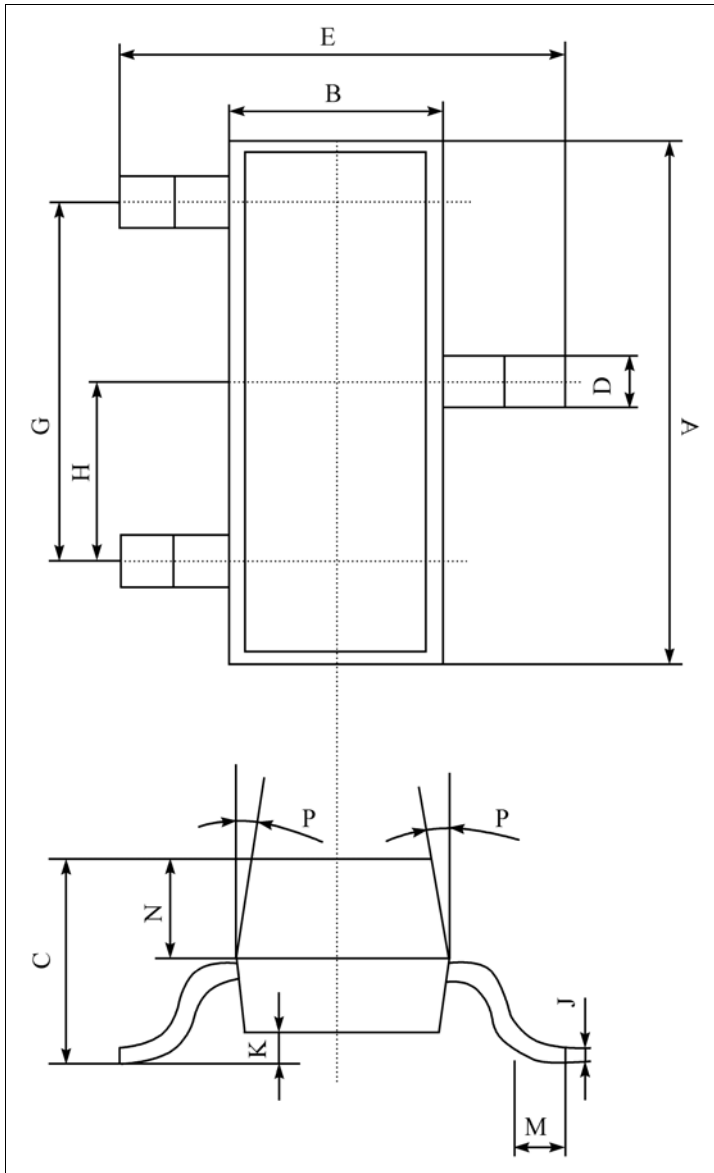

序号	数值及公差
A	2.90±0.10
B	1.30±0.10
C	1.00±0.10
D	0.40±0.10
E	2.40±0.20
G	1.90±0.10
H	0.95±0.05
J	0.13±0.05
K	0.00-0.10
M	≥0.20
N	0.60±0.10
P	7±2°

Packing
 SOT-23 包装规格
 SMD片式表面贴封装
 包装方式: 载带卷盘包装
Tape & Reel, 3Kpcs/Reel
 每卷数量3000只 (3Kpcs/Reel)
 每盒数量45000只 (45Kpcs/BOX)
 每箱数量180000只 (180Kpcs/Cartons)

SOT-23 Tape and reel

SOT-23 Embossed Carrier Tape

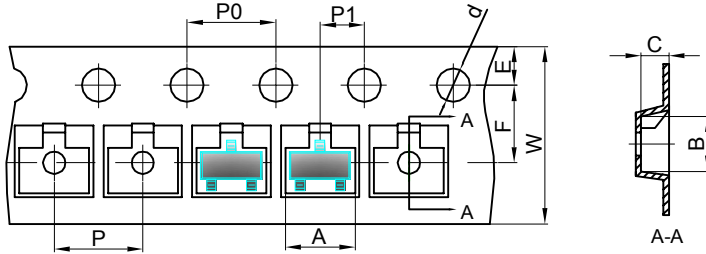

Dimensions are in millimeter										
Pkg type	A	B	C	d	E	F	P0	P	P1	W
SOT-23	3.15	2.77	1.22	Ø1.50	1.75	3.50	4.00	4.00	2.00	8.00

SOT-23 Tape Leader and Trailer

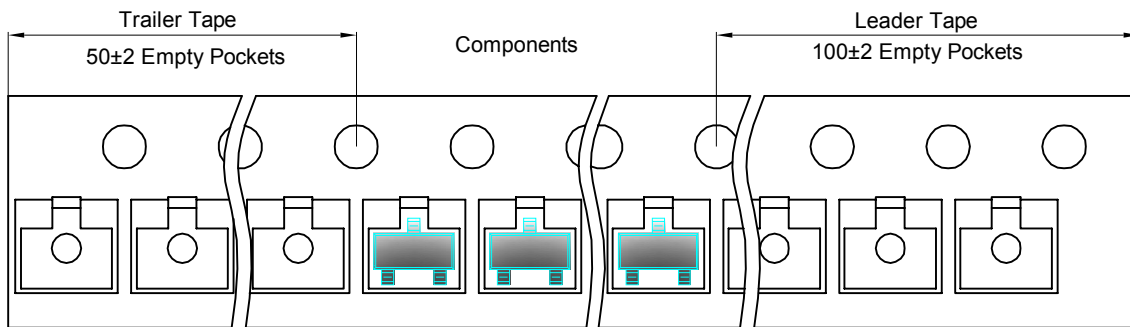

SOT-23 Reel

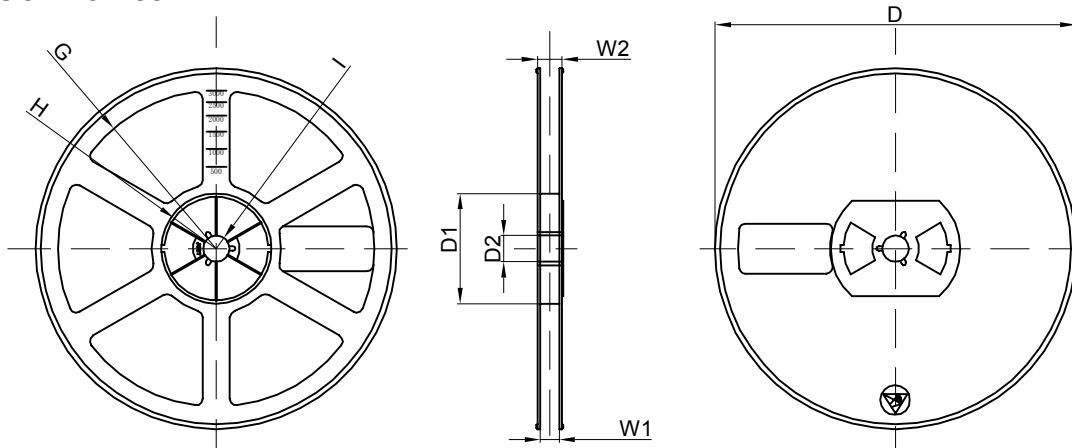

Dimensions are in millimeter								
Reel Option	D	D1	D2	G	H	I	W1	W2
7" Dia	Ø178.00	54.40	13.00	R78.00	R25.60	R6.50	9.50	12.30

REEL	Reel Size	Box	Box Size(mm)	Carton	Carton Size(mm)	G.W.(kg)
3000 pcs	7 inch	45,000 pcs	192×192×193	180,000 pcs	404×404×214	